

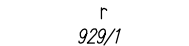





## LEGENDA

	stav podľa registra CKN
	
	stav podľa registra EKN
	
	dočasný záber
	trvalý záber

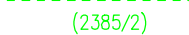
SO 101
SO 214
SO 630
SO 643
SO 712
SO 806

## Stav právny

Geometrický plán je podkladom na právne úkony, keď údaje doterajšieho stavu výkazu výmer sú zhodné s údajmi platných výpisov z katastra nehnuteľností

Vyhoviteľ  VIA PROXIMA EST VIA GEODETICCA Floriánska 19, 040 01 Košice IČO: 36 572 161	Kraj <i>Košický</i>	Okres <i>Košice-okolie</i>	Obec <i>Haniska</i>		
	Kat. územie <i>Haniska</i>	Číslo plánu <i>GDZV-26-78/2023</i>	Mapový list č <i>Veľká Ida 5-4/43, 5-4/44, 4-4/33, 4-5/31, 4-5/32</i>		
<b>PODKLAD</b> <i>na uzatváranie zmlúv – dočasný záber na stavbe „STRATEGICKÝ PARK VALALIKY – EXTERNÁ INFRAŠTRUKTÚRA“</i>					
Vyhotovil		Autorizačne overil		Úradne overil	
Dňa: <i>06.12.2023</i>	Meno: <i>Ing. Alena Némethová</i>	Dňa:	Meno:	Dňa:	Číslo:
Nové hranice boli v prírode označené <i>nestabilizované</i>		Náležitostami a presnosťou zodpovedá predpisom		Úradne overené podľa § 9 zákona NR SR č. 215/1995 Z.z. o geodézii a kartografii	
Záznam podrobného merania (meračský náčrt) č. -		Pečiatka a podpis		Pečiatka a podpis	
Súradnice bodov označených číslami a ostatné meračské údaje sú uložené vo všeobecnej dokumentácii					

## VÝKAZ VÝMER

Doterajší stav															Zmeny					Nový stav				
Číslo					Výmera		Druh pozemku	Diel číslo	k parcele číslo	m <sup>2</sup>	od parcely číslo	m <sup>2</sup>	Číslo parcely	Výmera		Druh pozemku	Vlastník ( iná oprávnená osoba ) adresa , (sídlo)							
pkzn. vložky	číslo vlastn.	parcely												ha	m <sup>2</sup>			ha	m <sup>2</sup>	kód				
PK	LV	PK	KN-E	KN-C																				
<b>Stav právny</b>																								
	1101		2385/2		1	2723	orná p.	1	SO 712	1005		( 2385/2	1	1486	orná p. )	Doterajší								
								2	SO 712	232														
	1573		2385/3		1	6085	orná p.	3	SO 712	330		( 2385/3	1	4736	orná p. )	detto								
								4	SO 712	1019														
	1574		2385/4			9484	orná p.	5	SO 712	780		( 2385/4		8704	orná p. )	detto								
	1575		2385/5		1	1215	orná p.	6	SO 712	1046		( 2385/5	1	0169	orná p. )	detto								
	2195		2385/6			9946	orná p.	7	SO 712	5		( 2385/6		9941	orná p. )	detto								
	1578		2391/1		1	3962	orná p.	8	SO 214	64		( 2391/1	1	3773	orná p. )	detto								
								9	SO 214	125														
	1579		2392		1	7201	ost.pl.	10	SO 214	228		( 2392	1	5069	ost.pl. )	detto								
								11	SO 214	1904														
	1606		2416/2		2	5198	orná p.	12	SO 214	4		( 2416/2	2	5194	orná p. )	detto								
	1607		2416/3			3360	orná p.	13	SO 214	83		( 2416/3		3277	orná p. )	detto								
	1608		2416/4			7378	orná p.	14	SO 214	42		( 2416/4		7336	orná p. )	detto								
	1881		2416/13		1	4310	orná p.	15	SO 214	273		( 2416/13	1	4037	orná p. )	detto								
	1129		2422/1		1	9590	orná p.	16	SO 806	60		( 2422/1	1	9530	orná p. )	detto								
	1617		2422/5		1	903	orná p.	17	SO 101	127		( 2422/5	1	0776	orná p. )	detto								

## VÝKAZ VÝMER

VÝKAZ VÝMER																	
Doterajší stav							Zmeny						Nový stav				
Číslo					Výmera		Druh pozemku	Diel číslo	k parcele číslo	m <sup>2</sup>	od parcely číslo	m <sup>2</sup>	Číslo parcely	Výmera		Druh pozemku	Vlastník ( iná oprávnená osoba ) adresa , (sídlo)
pzn. vložky	číslo vlastn.	parcely												ha	m <sup>2</sup>		
PK	LV	PK	KN-E	KN-C	ha	m <sup>2</sup>	ha	m <sup>2</sup>	ha	m <sup>2</sup>	ha	m <sup>2</sup>	kód	kód			
	1618		2422/6		1	1047	orná p.	18	SO 101	62		( 2422/6	1	0985	orná p. )	detto	
	1080		2428		2	6492	zast.pl.	19	SO 101 SO 643	3764		( 2428	2	2728	zast.pl. )	detto	
	1675		2430/2			8869	orná p.	20	SO 101	2151		( 2430/2		6718	orná p. )	detto	
	1632		2430/3		1	2185	orná p.	21	SO 101	2586		( 2430/3		9599	orná p. )	detto	
	1633		2430/4		1	1485	orná p.	22	SO 101	1879		( 2430/4		9606	orná p. )	detto	
	1254		2430/5			8560	t.t.p.	23	SO 101	1202		( 2430/5		7358	t.t.p. )	detto	
	1634		2430/6		1	1188	orná p.	24	SO 101	452		( 2430/6	1	0736	orná p. )	detto	
	2215		2460		14	3567	t.t.p.	25	SO 630	1933		( 2460	14	1634	t.t.p. )	detto	
								17			2422/5			127			
								18			2422/6			62			
								20			2430/2			2151			
								21			2430/3			2586			
								22			2430/4			1879			
								23			2430/5			1202			
								24			2430/6		SO 101	8459	ost.pl. 99	Valaliky Industrial Park, s.r.o. Trnavská cesta 100, Bratislava	
								19		2428	3764	SO 101 SO 643	3764	ost.pl. 99	Valaliky Industrial Park, s.r.o. Trnavská cesta 100, Bratislava		

## VÝKAZ VÝMER

Doterajší stav					Zmeny					Nový stav							
Číslo					Výmera		Druh pozemku	Diel číslo	k parcele číslo	m <sup>2</sup>	od parcely číslo	m <sup>2</sup>	Číslo parcely	Výmera		Druh pozemku	Vlastník ( iná oprávnená osoba ) adresa , (sídlo)
pkzn. vložky	číslo vlastn.	parcely												ha	m <sup>2</sup>		
PK	LV	PK	KN-E	KN-C													
							8			2391/1	64						
							9			2391/1	125						
							10			2392	228						
							11			2392	1904						
							12			2416/2	4						
							13			2416/3	83						
							14			2416/4	42						
							15			2416/13	273	SO 214	2723	ost.pl. 99	Valaliky Industrial Park, s.r.o. Trnavská cesta 100, Bratislava		
							25			2460	1933	SO 630	1933	ost.pl. 99	Valaliky Industrial Park, s.r.o. Trnavská cesta 100, Bratislava		
							1			2385/2	1005						
							2			2385/2	232						
							3			2385/3	330						
							4			2385/3	1019						
							5			2385/4	780						
							6			2385/5	1046						
							7			2385/6	5	SO 712	4417	ost.pl. 99	Valaliky Industrial Park, s.r.o. Trnavská cesta 100, Bratislava		
							16			2422/1	60	SO 806	60	ost.pl. 99	Valaliky Industrial Park, s.r.o. Trnavská cesta 100, Bratislava		
<b>Spolu</b>					<b>40</b>	<b>4748</b>					<b>21356</b>	<b>21356</b>	<b>40</b>	<b>4748</b>			

Legenda: kód spôsobu využívania

99 Pozemok využívaný podľa druhu pozemku



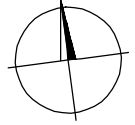

Г  
936/1

obec Gežka, k.ú. Gežka  
obec Haniska, k.ú. Haniska

47  
48  
-2,00-

Г  
956

(2460)

SO 630

-324,26-

-320,40-

(25)

948/1 →

≠ 957/1

958 →

Г  
960/1

Г  
969/1

Г  
936/27

Mierka 1 : 1000

Г 969/5  
≠ 957/3

Г  
969/2

948/2 →

948/3 →

Г  
936/28

Г 969/3

Г 961/3

